

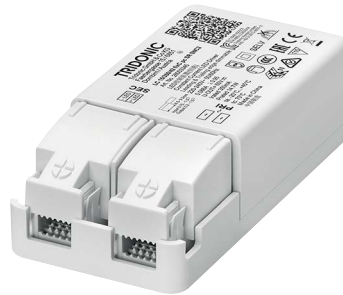

Driver LC 15W 350mA fixC pc SR SNC2 essence series

Product description

- Dimmable constant current LED driver (SELV)
- Independent driver with strain-relief housing
- Extra flat housing for constrained installation conditions (small ceiling cut outs and low ceiling voids)
- Dimmable via trailing and leading edge phase dimmers
- Dimming range 5 to 100 % (depending on dimmer)
- For luminaires with M and MM as per EN 60598, VDE 0710 and VDE 0711
- Max. output power 14.7 W
- Output current 350 mA
- Nominal lifetime up to 50,000 h
- 5 years guarantee (conditions at www.tridonic.com)



Housing properties

- Casing: polycarbonat, white
- Type of protection IP20
- Push-in terminals
- 2 separate strain relief parts for input and output cables with highly robust clamps

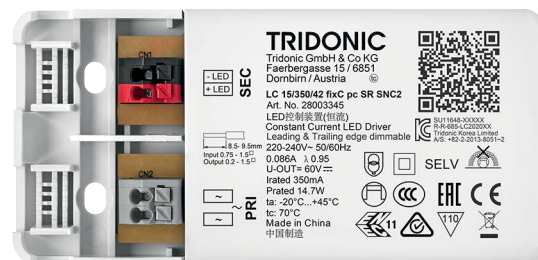

Functions

- Overload protection
- Short-circuit protection
- No-load protection
- No output current overshoot at mains on/off



Standards, page 3

Wiring diagrams and installation examples, page 3





Driver LC 15W 350mA fixC pc SR SNC2 essence series

Technical data

Rated supply voltage	220 – 240 V
AC voltage range	198 – 264 V
Mains frequency	50/60 Hz
Overvoltage protection	320 V AC, 1 h
λ at full load ^①	0,95
λ at min. load ^①	0,95
THD (at 230 V, 50 Hz, full load)	< 10 %
THD (at 230 V, 50 Hz, min. load)	< 12 %
Output current tolerance (at 230 V, 50 Hz, full load) ^②	± 7,5 %
Output current tolerance (at 230 V, 50 Hz, min. load) ^②	± 7,5 %
Output LF current ripple (< 120 Hz) at full load	± 3 %
Output P_{STLM} (at full load)	≤ 1
Output SVM (at full load)	≤ 0,4
Starting time (at 230 V, 50 Hz, full load)	≤ 0,5 s
Turn off time (at 230 V, 50 Hz, full load)	≤ 0,5 s
Hold on time at power failure	0 s
Ambient temperature t_a	-20 ... +45 °C
Ambient temperature t_a (at lifetime 50,000 h)	35 °C
Storage temperature t_s	-40 ... +80 °C
Mains burst capability	1 kV
Mains surge capability (between L – N)	1 kV
Mains surge capability (between L/N – PE)	2 kV
Surge voltage at output side (against PE)	2,5 kV
Lifetime	up to 50,000 h
Guarantee (conditions at www.tridonic.com)	5 years
Dimensions L x W x H	101,5 x 49 x 29 mm

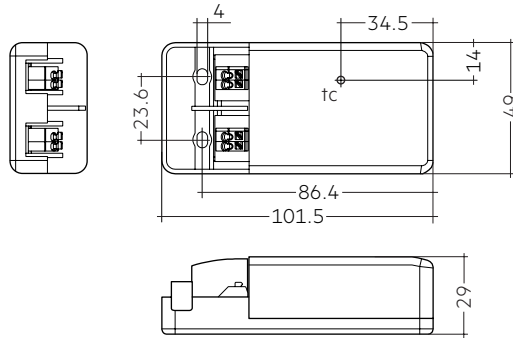

Ordering data

Type	Article number	Packaging, carton	Packaging, pallet	Weight per pc.
LC 15/350/42 fixC pc SR SNC2	28003345	10 pc(s).	3,000 pc(s).	0,085 kg

Specific technical data

Type	Output current ^②	Typ. current consumption (at 230 V, 50 Hz, full load)	Typ. power consumption (at 230 V, 50 Hz, full load)	Output power	Efficiency at full load ^①	Efficiency at min. load ^①	Min. forward voltage ^①	Max. forward voltage ^①	Max. output voltage (U-OUT)	Max. peak output current	Max. casing temperature t_c
LC 15/350/42 fixC pc SR SNC2	350 mA	0,086 A	179 W	9,5 – 14,7 W	82 %	80 %	27 V	42 V	60 V	384 mA	70 °C

^① Test result at 230 V, 50 Hz without dimmer connected.

^② Output current is mean value.

1. Standards

EN 55015
EN 61000-3-2
EN 61000-3-3
EN 61347-1
EN 61347-2-13
EN 61547
EN 62384

1.1 Glow wire test

according to EN 60598-1 with increased temperature of 850 °C passed.

2. Thermal details and lifetime

2.1 Expected lifetime

Expected lifetime			
Type	ta	35 °C	45 °C
LC 15/350/42 fixC pc SR SNC2	tc	60 °C	70 °C
	Lifetime	50,000 h	30,000 h

The LED drivers are designed for a lifetime stated above under reference conditions and with a failure probability of less than 10 %.

The relation of tc to ta temperature depends also on the luminaire design. If the measured tc temperature is approx. 5 K below tc max., ta temperature should be checked and eventually critical components (e.g. ELCAP) measured. Detailed information on request.

3. Installation / wiring

3.1 Circuit diagram

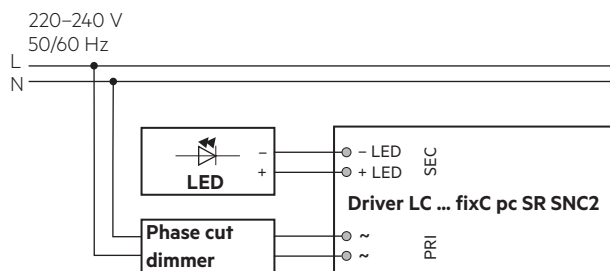

3.2 Wiring type and cross section

The wiring can be in stranded wires with ferrules or solid. For perfect function of the cage clamp terminals the strip length should be 8.5 – 9.5 mm for the input terminal.

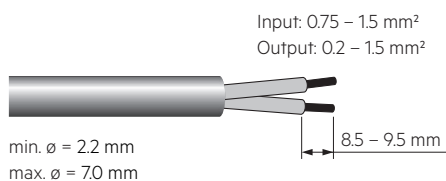

3.3 Fixing conditions when using as independent Driver with Clip-On

Dry, acidfree, oilfree, fatfree. It is not allowed to exceed the maximum ambient temperature (ta) stated on the device. Minimum distances stated below are recommendations and depend on the actual luminaire. Is not suitable for fixing in corner.

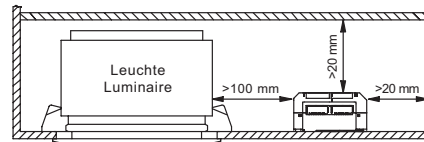

3.4 Wiring guidelines

- All connections must be kept as short as possible to ensure good EMI behaviour.
- Mains leads should be kept apart from LED driver and other leads (ideally 5 – 10 cm distance)
- Max. length of output wires is 2 m.
- To comply with the EMC regulations run the secondary wires (LED module) in parallel.
- Secondary switching is not permitted.
- Incorrect wiring can damage LED modules.
- To avoid the damage of the Driver, the wiring must be protected against short circuits to earth (sharp edged metal parts, metal cable clips, louver, etc.).

3.5 Replace LED module

1. Mains off
2. Remove LED module
3. Wait for 20 seconds
4. Connect LED module again

Hot plug-in or secondary switching of LEDs is not permitted and may cause a very high current to the LEDs.

3.6 Installation instructions

The LED module and all contact points within the wiring must be sufficiently insulated against 2.5 kV surge voltage. Air and creepage distance must be maintained.

3.7 Mounting of device

Max. torque for fixing: 0.5 Nm/M4

4. Electrical values

4.1 Diagrams LC 15W 350mA fixC pc SR SNC2

4.1.1 Efficiency vs load

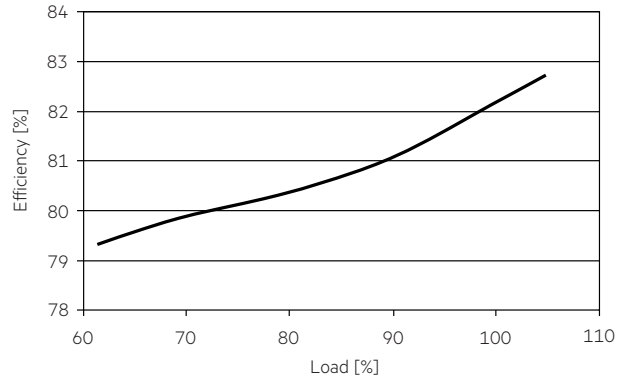

4.1.4 Input current vs load

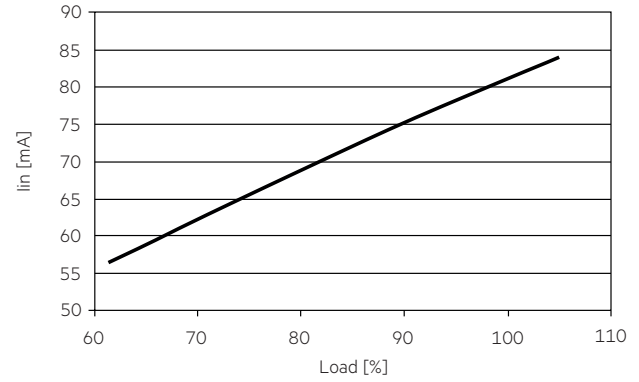

4.1.2 Power factor vs load

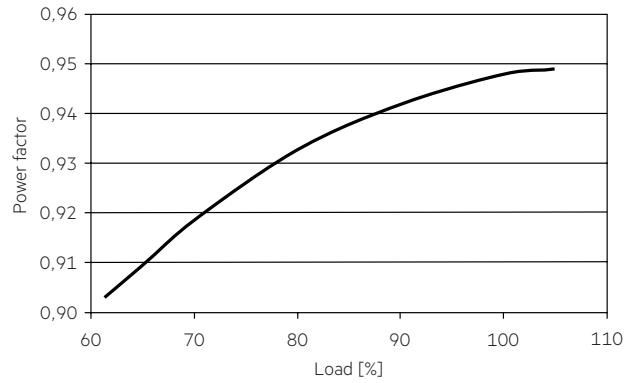

4.1.5 THD vs load

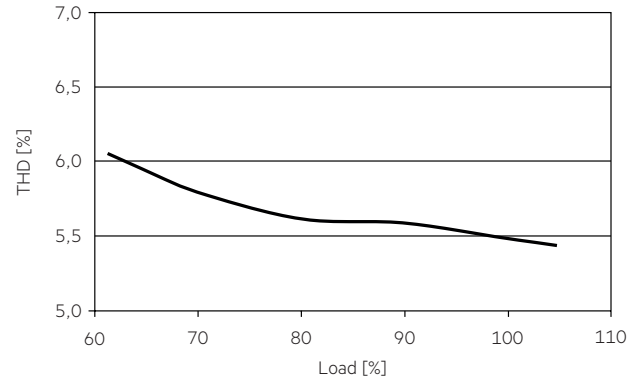

4.1.3 Input power vs load

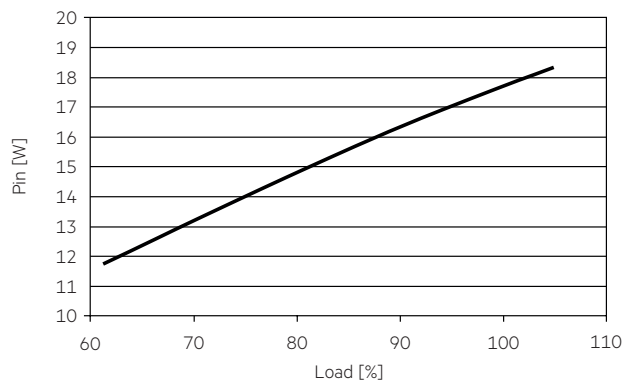

4.1.6 Phase cut dimming curve (depends dimmer)

Output current vs dimming

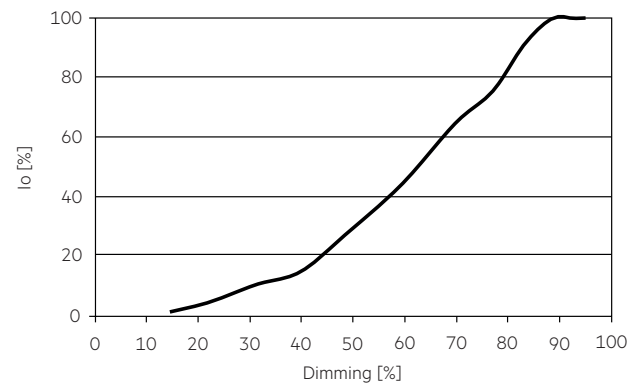

4.2 Maximum loading of automatic circuit breakers in relation to inrush current

Automatic circuit breaker type	C10	C13	C16	C20	B10	B13	B16	B20	Inrush current	
									I_{max}	Time
Installation Ø	1.5 mm ²	1.5 mm ²	2.5 mm ²	2.5 mm ²	1.5 mm ²	1.5 mm ²	2.5 mm ²	2.5 mm ²	I_{max}	Time
LC 15/350/42 fixC pc SR SNC2	57	72	82	95	34	43	49	57	1015 A	185 µs

These are max. values calculated out of inrush current! Please consider not to exceed the maximum rated continuous current of the circuit breaker. Calculation uses typical values from ABB series S200 as a reference. Actual values may differ due to used circuit breaker types and installation environment.

4.3 Harmonic distortion in the mains supply (at 230 V / 50 Hz and full load) in %

	THD	3.	5.	7.	9.	11.
LC 15/350/42 fixC pc SR SNC2	< 10	< 6	< 4	< 5	< 4	< 3

Acc. to 6100-3-2. Harmonics < 5 mA or < 0.6 % (whatever is greater) of the input current are not considered for calculation of THD.

5. Functions

5.1 Overload protection

If the maximum load is exceeded by a defined internal limit, the LED driver will protect itself. After elimination of the overload the nominal operation is restored automatically.

5.2 Short-circuit behaviour

In case of a short circuit on the secondary side (LED) the LED control gear switches into hic-cup mode. After the removal of the short-circuit fault the LED control gear will recover automatically.

5.3 No-load operation

The LED driver works in burst working mode to provide a constant output voltage regulation which allows the application to be able to work safely when LED string open due a failure. In no-load operation the output voltage will not exceed the specified max. output voltage (see page 2).

6. Miscellaneous

6.1 Insulation and electric strength testing of luminaires

Electronic devices can be damaged by high voltage. This has to be considered during the routine testing of the luminaires in production.

According to IEC 60598-1 Annex Q (informative only!) or ENEC 303-Annex A, each luminaire should be submitted to an insulation test with 500 V_{DC} for 1 second. This test voltage should be connected between the interconnected phase and neutral terminals and the earth terminal. The insulation resistance must be at least 2 MΩ.

As an alternative, IEC 60598-1 Annex Q describes a test of the electrical strength with 1500 V_{AC} (or 1.414 x 1500 V_{DC}). To avoid damage to the electronic devices this test must not be conducted.

6.2 Conditions of use and storage

Humidity: 5% up to max. 85%,
not condensed
(max. 56 days/year at 85%)

Storage temperature: -40 °C up to max. +80 °C

The devices have to be within the specified temperature range (ta) before they can be operated.

6.3 Maximum number of switching cycles

All LED driver are tested with 50,000 switching cycles. Turning the device off and on must be done after 1 second. If the device is turned off and on for less than 1 second, it is possible that the device will delay startup ~5 seconds.

6.4 Additional information

Additional technical information at www.tridonic.com → Technical Data

Lifetime declarations are informative and represent no warranty claim. No warranty if device was opened.